

## De-composed Base Schema with ebXML Structures

### *batch.details*

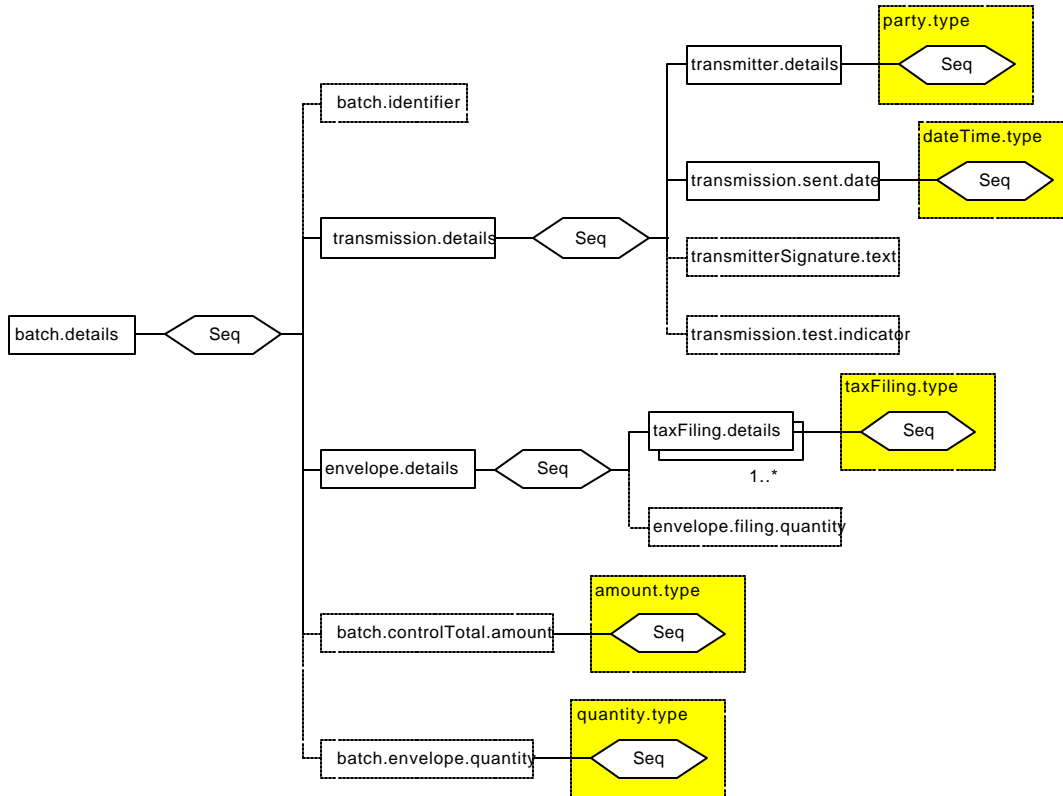

```

<?xml version="1.0" encoding="UTF-8"?>
<xsd:schema xmlns:xsd="http://www.w3.org/2001/XMLSchema" elementFormDefault="qualified"
attributeFormDefault="qualified">
  <xsd:include schemaLocation="partyType.xsd"/>
  <xsd:include schemaLocation="taxFilingType.xsd"/>
  <xsd:include schemaLocation="dateTimeType.xsd"/>
  <xsd:include schemaLocation="amountType.xsd"/>
  <xsd:include schemaLocation="quantityType.xsd"/>
  <xsd:element name="batch.details">
    <xsd:complexType>
      <xsd:sequence>
        <xsd:element name="batch.identifier" type="xsd:string" minOccurs="0"/>
        <xsd:element name="transmission.details">
          <xsd:complexType>
            <xsd:sequence>
              <xsd:element name="transmitter.details" type="party.type"/>
              <xsd:element name="transmission.sent.date" type="dateTime.type"/>
              <xsd:element name="transmitterSignature.text" minOccurs="0">
                <xsd:complexType/>
              </xsd:element>
              <xsd:element name="transmission.test.indicator" type="xsd:boolean" minOccurs="0"/>
            </xsd:sequence>
          </xsd:complexType>
        </xsd:element>
      </xsd:sequence>
    </xsd:complexType>
  </xsd:element>

```

```
<xsd:element name="envelope.details">
  <xsd:complexType>
    <xsd:sequence>
      <xsd:element name="taxFiling.details" type="taxFiling.type"
maxOccurs="unbounded"/>
      <xsd:element name="envelope.filing.quantity" minOccurs="0"/>
    </xsd:sequence>
  </xsd:complexType>
</xsd:element>
<xsd:element name="batch.controlTotal.amount" type="amount.type" minOccurs="0"/>
<xsd:element name="batch.envelope.quantity" type="quantity.type" minOccurs="0"/>
</xsd:sequence>
</xsd:complexType>
</xsd:element>
</xsd:schema >
```

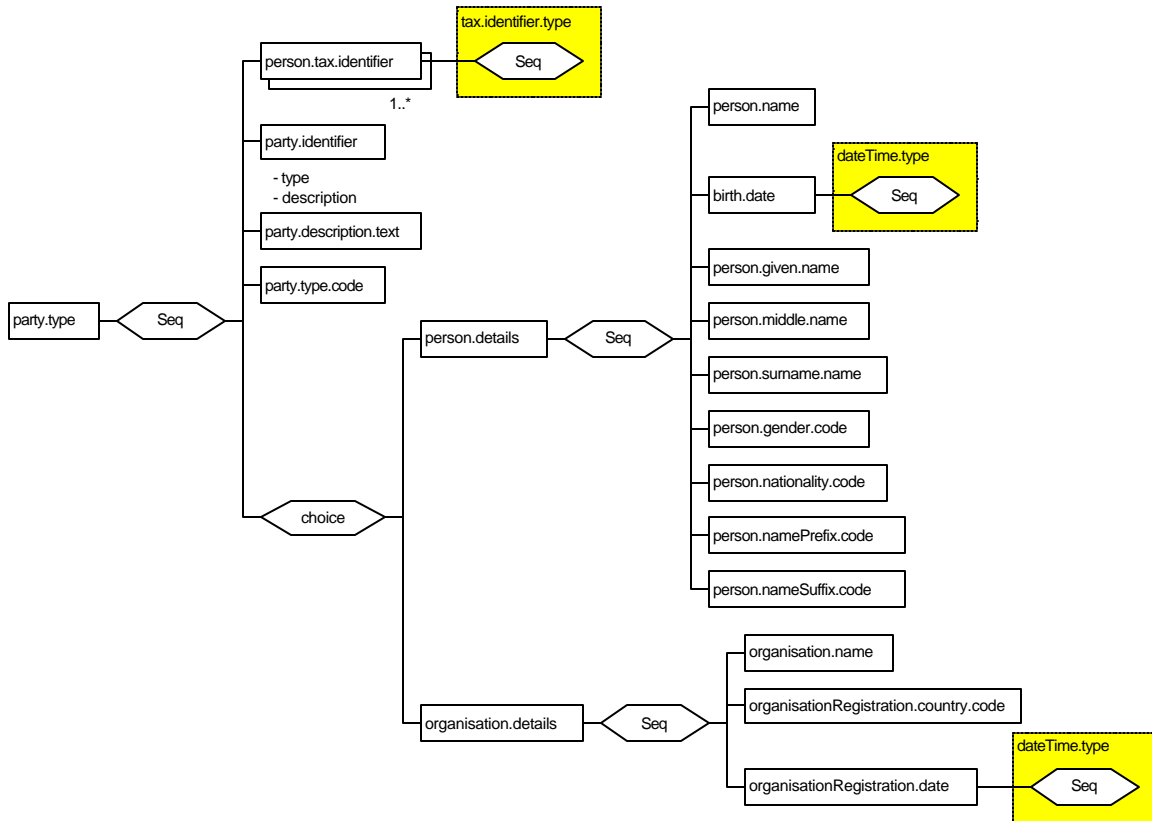
**party.type**

```

<?xml version="1.0" encoding="UTF-8"?>
<xsd:schema xmlns:xsd="http://www.w3.org/2001/XMLSchema" elementFormDefault="qualified">
  <xsd:include schemaLocation="taxIDType.xsd"/>
  <xsd:complexType name="party.type">
    <xsd:annotation>
      <xsd:documentation>Party type definition, where party can be a person, a company,
etc.</xsd:documentation>
    </xsd:annotation>
    <xsd:sequence>
      <xsd:element name="party.tax.identifier" type="taxIdentifier.type" maxOccurs="unbounded"/>
      <xsd:element name="party.identifier">
        <xsd:complexType>
          <xsd:simpleContent>
            <xsd:extension base="xsd:string">
              <xsd:attribute name="type" type="xsd:string" use="required"/>
              <xsd:attribute name="description" type="xsd:string" use="optional"/>
            </xsd:extension>
          </xsd:simpleContent>
        </xsd:complexType>
      </xsd:element>
      <xsd:element name="party.description.text" type="xsd:string"/>
      <xsd:element name="party.type.code" type="xsd:NMTOKEN"/>
      <xsd:choice>
        <xsd:element name="person.details">
          <xsd:complexType>
            <xsd:sequence>

```

```

<xsd:element name="person.name" type="xsd:string" minOccurs="0"/>
<xsd:element name="birth.date" type="dateTime.type" minOccurs="0"/>
<xsd:element name="person.given.name" type="xsd:string" minOccurs="0"/>
<xsd:element name="person.middle.name" type="xsd:string" minOccurs="0"/>
<xsd:element name="person.surname.name" type="xsd:string" minOccurs="0"/>
<xsd:element name="person.gender.code" minOccurs="0">
  <xsd:simpleType>
    <xsd:restriction base="xsd:NMTOKEN">
      <xsd:enumeration value="Male"/>
      <xsd:enumeration value="Female"/>
    </xsd:restriction>
  </xsd:simpleType>
</xsd:element>
<xsd:element name="person.nationality.code" type="xsd:NMTOKEN" minOccurs="0"/>
<xsd:element name="person.namePrefix.code" minOccurs="0">
  <xsd:simpleType>
    <xsd:restriction base="xsd:NMTOKEN">
      <xsd:enumeration value="Mr"/>
      <xsd:enumeration value="Mrs"/>
      <xsd:enumeration value="Ms"/>
      <xsd:enumeration value="Dr"/>
    </xsd:restriction>
  </xsd:simpleType>
</xsd:element>
<xsd:element name="person.nameSuffix.code" minOccurs="0">
  <xsd:simpleType>
    <xsd:restriction base="xsd:NMTOKEN">
      <xsd:enumeration value="Jr."/>
      <xsd:enumeration value="Sr."/>
    </xsd:restriction>
  </xsd:simpleType>
</xsd:element>
<xsd:element name="person.alias.name" type="xsd:string" minOccurs="0"/>
</xsd:sequence>
</xsd:complexType>
</xsd:element>
<xsd:element name="organization.details">
  <xsd:complexType>
    <xsd:sequence>
      <xsd:element name="organization.name" type="xsd:string"/>
      <xsd:element name="organizationRegistration.country.code" type="xsd:NMTOKEN"/>
      <xsd:element name="organizationRegistration.date" type="dateTime.type"/>
      <xsd:element name="organization.alias.name" type="xsd:string"/>
    </xsd:sequence>
  </xsd:complexType>
</xsd:element>
</xsd:choice>
</xsd:sequence>
</xsd:complexType>
</xsd:schema >

```

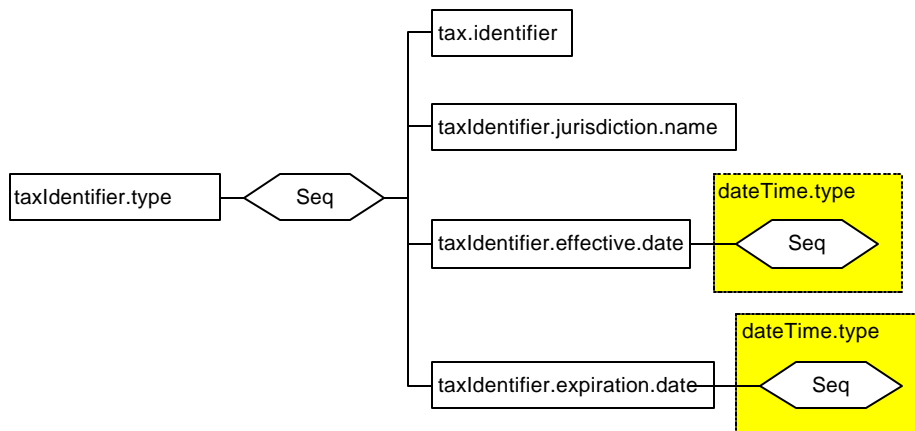
**taxIdentifier.type**

```

<?xml version="1.0" encoding="UTF-8"?>
<xsd:schema xmlns:xsd="http://www.w3.org/2001/XMLSchema" elementFormDefault="qualified">
  <xsd:include schemaLocation="dateTimeType.xsd"/>
  <xsd:complexType name="taxIdentifier.type">
    <xsd:annotation>
      <xsd:documentation>Defines a unique tax identifier given by a taxing
jurisdiction.</xsd:documentation>
    </xsd:annotation>
    <xsd:sequence>
      <xsd:element name="taxIdentifier.code" type="xsd:string"/>
      <xsd:element name="jurisdiction.name" type="xsd:string"/>
      <xsd:element name="taxIdentifier.effective.date" type="dateTime.type"/>
      <xsd:element name="taxIdentifier.expiration.date" type="dateTime.type"/>
    </xsd:sequence>
    <xsd:attribute name="type" use="optional">
      <xsd:simpleType>
        <xsd:restriction base="xsd:string">
          <xsd:enumeration value="Country"/>
          <xsd:enumeration value="State"/>
          <xsd:enumeration value="County"/>
          <xsd:enumeration value="City"/>
          <xsd:enumeration value="District"/>
        </xsd:restriction>
      </xsd:simpleType>
    </xsd:attribute>
  </xsd:complexType>
</xsd:schema >

```

## taxFiling.type

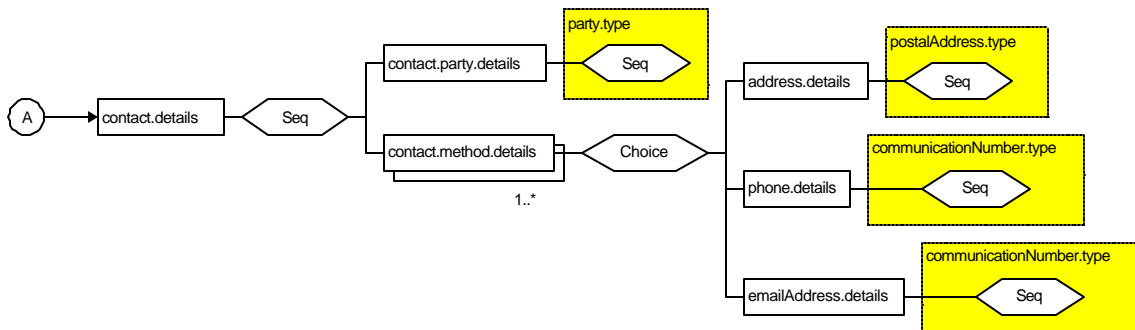
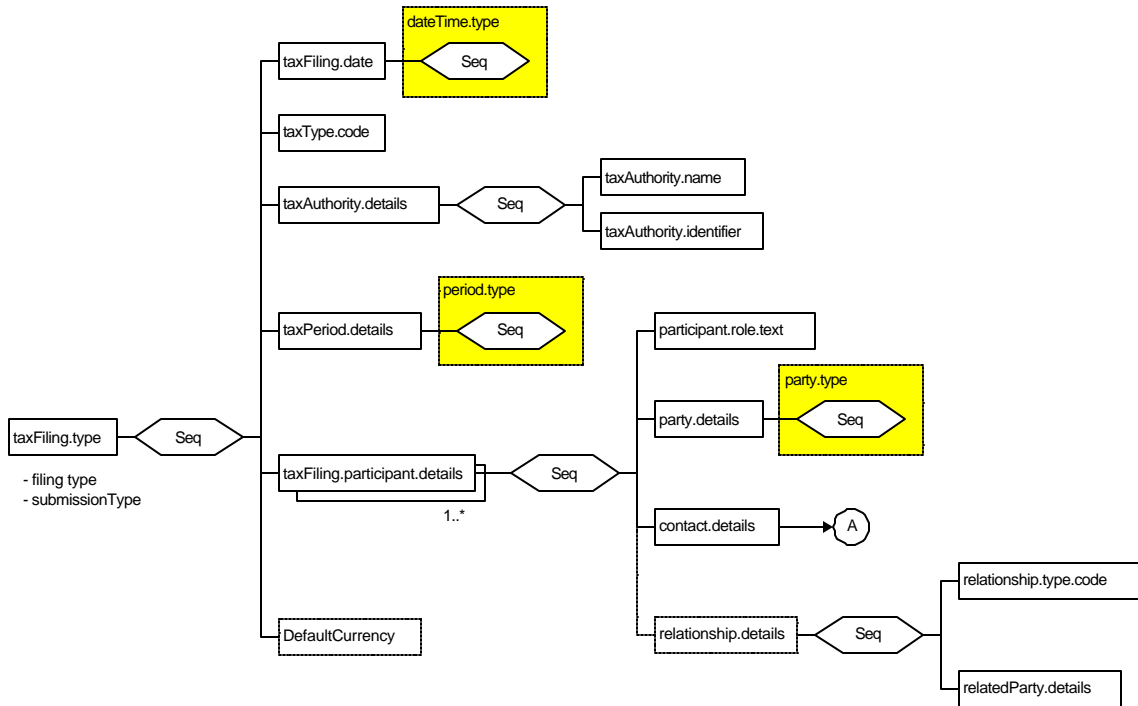

```

<?xml version="1.0" encoding="UTF-8"?>
<xsd:schema xmlns:xsd="http://www.w3.org/2001/XMLSchema" elementFormDefault="qualified">
  <xsd:include schemaLocation="remittance.xsd"/>
  <xsd:include schemaLocation="periodType.xsd"/>
  <xsd:include schemaLocation="partyType.xsd"/>
  <xsd:include schemaLocation="postalAddressType.xsd"/>
  <xsd:include schemaLocation="communicationNumberType.xsd"/>
  <xsd:include schemaLocation="currencyType.xsd"/>
  <xsd:complexType name="taxFiling.type">
    <xsd:sequence>
      <xsd:element name="taxFiling.date" type="dateTime.type"/>
      <xsd:element name="tax.type.code">
        <xsd:simpleType>

```

```

        <xsd:restriction base="xsd:NMTOKEN" >
          <xsd:enumeration value=" Sales Tax" />
          <xsd:enumeration value=" Sales and Use Tax" />
          <xsd:enumeration value=" Income Tax" />
          <xsd:enumeration value=" Motor Fuel Tax" />
          <xsd:enumeration value=" Payroll Tax" />
        </xsd:restriction>
      </xsd:simpleType>
    </xsd:element>
    <xsd:element name="taxAuthority.details">
      <xsd:complexType>
        <xsd:sequence>
          <xsd:element name="taxAuthority.name" type="xsd:string"/>
          <xsd:element name="taxAuthority.identifier" type="xsd:string" minOccurs="0"/>
        </xsd:sequence>
        <xsd:attribute name="type" use="required">
          <xsd:simpleType>
            <xsd:restriction base="xsd:string">
              <xsd:enumeration value=" State" />
              <xsd:enumeration value=" County" />
              <xsd:enumeration value=" City" />
              <xsd:enumeration value=" District" />
            </xsd:restriction>
          </xsd:simpleType>
        </xsd:attribute>
      </xsd:complexType>
    </xsd:element>
    <xsd:element name="taxPeriod.details" type="period.type"/>
    <xsd:element name="taxFiling.participant.details" maxOccurs="unbounded">
      <xsd:complexType>
        <xsd:sequence>
          <xsd:element name="participant.role.text" type="xsd:string"/>
          <xsd:element name="party.details" type="party.type"/>
          <xsd:element name="contact.details">
            <xsd:complexType>
              <xsd:sequence>
                <xsd:element name="contact.party.details" type="party.type"/>
                <xsd:element name="contact.method.details" maxOccurs="unbounded">
                  <xsd:complexType>
                    <xsd:choice>
                      <xsd:element name="address.details" type="postalAddress.type"/>
                      <xsd:element name="phone.details"
type="communicationNumber.type"/>
                      <xsd:element name="emailAddress.text"
type="communicationNumber.type"/>
                    </xsd:choice>
                  </xsd:complexType>
                </xsd:element>
              </xsd:sequence>
            </xsd:complexType>
          </xsd:element>
        </xsd:sequence>
        <xsd:element name="relationship.details" minOccurs="0" maxOccurs="unbounded">
          <xsd:complexType>
            <xsd:sequence>
              <xsd:element name="relationship.type.code" type="xsd:string"/>
              <xsd:element name="relatedParty.details" type="party.type"/>
            </xsd:sequence>
          </xsd:complexType>
        </xsd:element>
      </xsd:sequence>
    </xsd:complexType>
  </xsd:element>
  <xsd:element name="defaultCurrency.details" type="currency.type" minOccurs="0"/>
</xsd:sequence>
<xsd:attribute name="filingType" use="required">
  <xsd:simpleType>

```

```

<xsd:restriction base="xsd:string">
  <xsd:enumeration value="tax return"/>
  <xsd:enumeration value="tax remittance"/>
  <xsd:enumeration value="tax filing application"/>
</xsd:restriction>
</xsd:simpleType>
</xsd:attribute>
<xsd:attribute name="submissionType" use="required">
  <xsd:simpleType>
    <xsd:restriction base="xsd:string">
      <xsd:enumeration value="Additional Information"/>
      <xsd:enumeration value="Re-submission"/>
      <xsd:enumeration value="New Filing"/>
    </xsd:restriction>
  </xsd:simpleType>
</xsd:attribute>
</xsd:complexType>
</xsd:schema>

```

### taxInformation.type

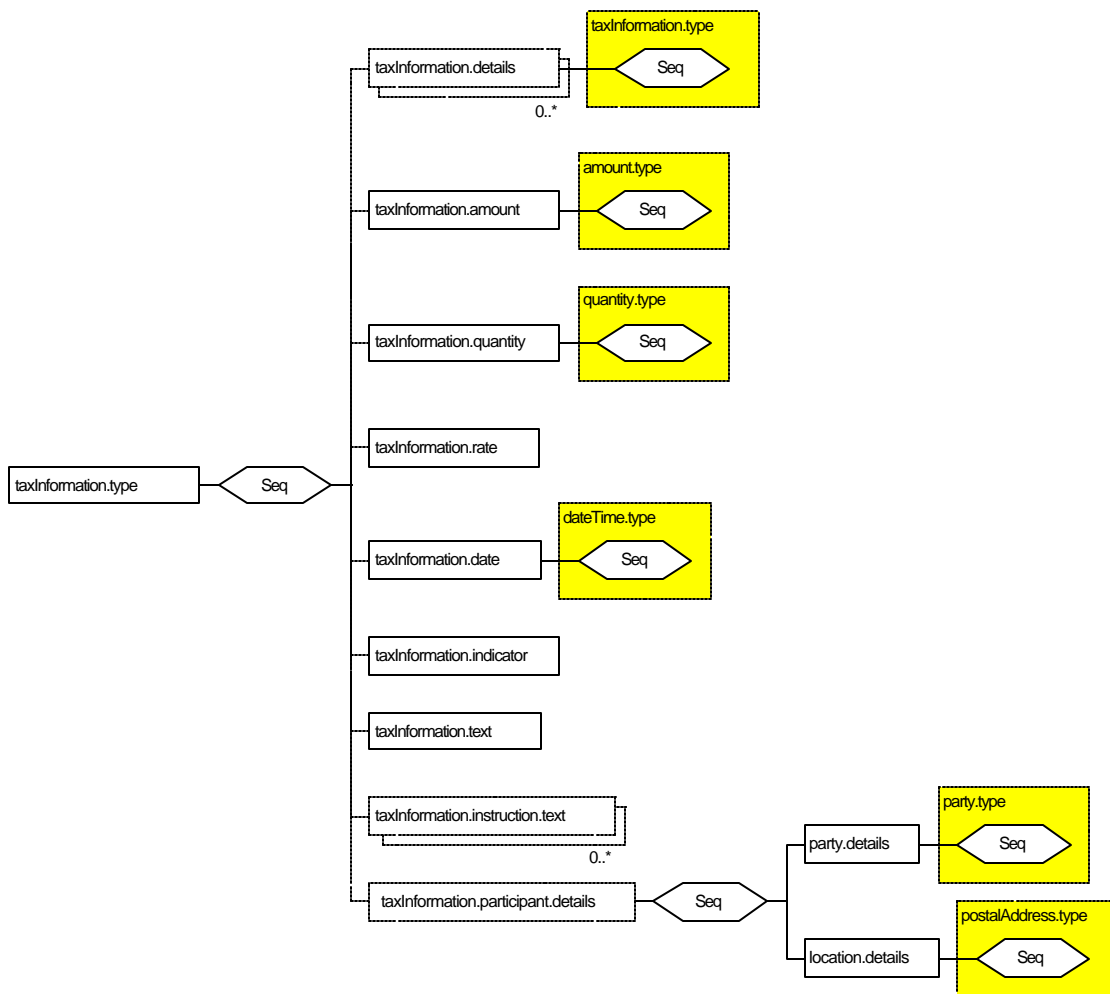



```

<?xml version="1.0" encoding="UTF-8"?>
<xsd:schema xmlns:xsd="http://www.w3.org/2001/XMLSchema" elementFormDefault="qualified">
  <xsd:include schemaLocation="amountType.xsd"/>
  <xsd:include schemaLocation="quantityType.xsd"/>
  <xsd:include schemaLocation="dateTimeType.xsd"/>
  <xsd:include schemaLocation="postalAddressType.xsd"/>
  <xsd:include schemaLocation="partyType.xsd"/>
  <xsd:complexType name="taxInformation.type">
    <xsd:annotation>
      <xsd:documentation>Tax Information type</xsd:documentation>
    </xsd:annotation>
    <xsd:sequence>
      <xsd:element name="taxInformation.details" type="taxInformation.type" minOccurs="0"
maxOccurs="unbounded"/>
      <xsd:element name="taxInformation.amount" type="amount.type" minOccurs="0"
maxOccurs="unbounded"/>
      <xsd:element name="taxInformation.quantity" type="quantity.type" minOccurs="0"/>
      <xsd:element name="taxInformation.rate" type="xsd:decimal" minOccurs="0"/>
      <xsd:element name="taxInformation.date" type="dateTime.type" minOccurs="0"/>
      <xsd:element name="taxInformation.indicator" type="xsd:string" minOccurs="0"/>
      <xsd:element name="taxInformation.text" type="xsd:string" minOccurs="0"/>
      <xsd:element name="taxInformation.instruction.text" type="xsd:string" minOccurs="0"
maxOccurs="unbounded"/>
      <xsd:element name="taxInformation.participant.details" minOccurs="0">
        <xsd:complexType>
          <xsd:sequence>
            <xsd:element name="party.details" minOccurs="0" maxOccurs="unbounded">
              <xsd:complexType>
                <xsd:sequence>
                  <xsd:element name="party.details" type="party.type" minOccurs="0"
maxOccurs="unbounded"/>
                  <xsd:element name="location.details" type="postalAddress.type"
minOccurs="0"/>
                </xsd:sequence>
              </xsd:complexType>
            </xsd:element>
          </xsd:sequence>
        </xsd:complexType>
      </xsd:element>
      <xsd:attribute name="description" type="xsd:string" use="optional"/>
    </xsd:sequence>
  </xsd:complexType>
</xsd:schema>

```

## Remittance

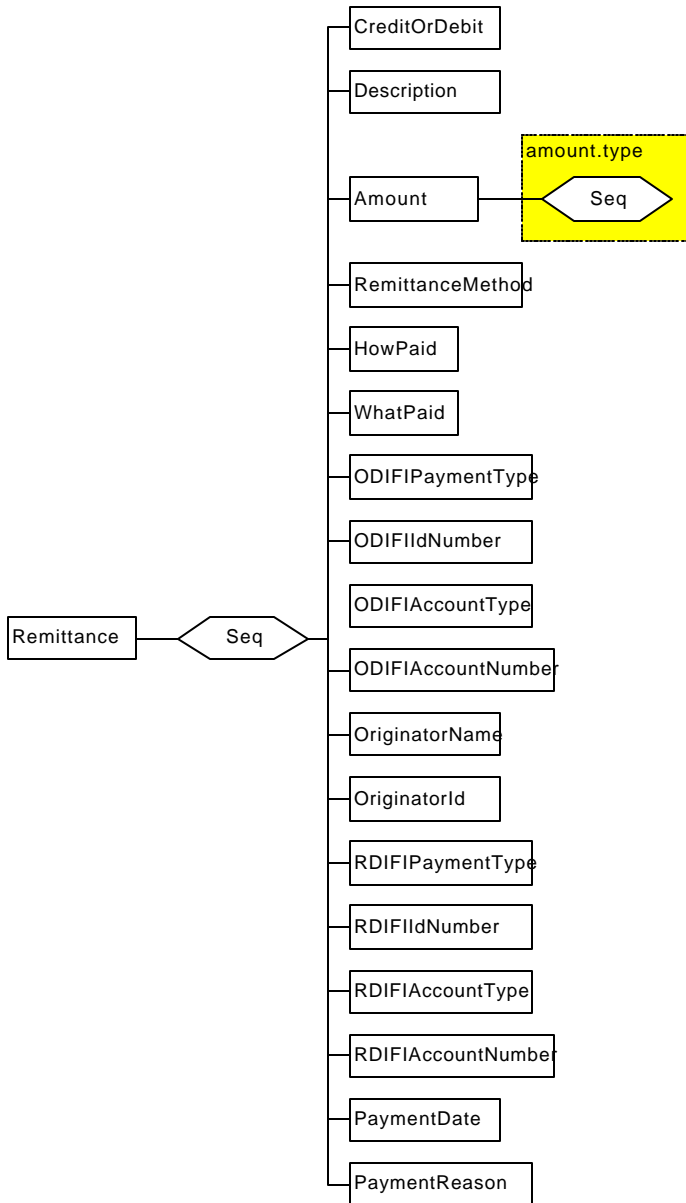

```

<?xml version="1.0" encoding="UTF-8"?>
<xsd:schema xmlns:xsd="http://www.w3.org/2000/10/XMLSchema" elementFormDefault="unqualified">
  <xsd:include schemaLocation="amountType.xsd"/>
  <xsd:complexType name="Remittance">
    <xsd:sequence>
      <xsd:element name="CreditOrDebit"/>
      <xsd:element name="Description"/>
      <xsd:element name="Amount" type="amount.type"/>
      <xsd:element name="RemittanceMethod"/>
      <xsd:element name="HowPaid"/>
      <xsd:element name="WhatPaid"/>
      <xsd:element name="ODIFIPaymentType"/>
      <xsd:element name="ODIFIIdNumber"/>
    
```

```
<xsd:element name="ODIFIAccountType"/>
<xsd:element name="ODIFIAccountNumber"/>
<xsd:element name="OriginatorName"/>
<xsd:element name="OriginatorId"/>
<xsd:element name="RDIFIPaymentType"/>
<xsd:element name="RDIFIdNumber"/>
<xsd:element name="RDIFIAccountType"/>
<xsd:element name="RDIFIAccountNumber"/>
<xsd:element name="PaymentDate"/>
<xsd:element name="PaymentReason"/>
</xsd:sequence>
</xsd:complexType>
</xsd:schema >
```

## *postalAddress.type*



```

<?xml version="1.0" encoding="UTF-8"?>
<!-- edited with XML Spy v3.5 (http://www.xmlspy.com) by John Glaubit (Vertex Inc.) -->
<xsd:schema xmlns:xsd="http://www.w3.org/2000/10/XMLSchema" elementFormDefault="qualified">
  <xsd:complexType name="postalAddress.type">
    <xsd:annotation>
      <xsd:documentation>Comment describing your root element</xsd:documentation>
    
```

```

</xsd:annotation>
<xsd:sequence>
  <xsd:element name="address.type.code"/>
  <xsd:element name="streetBuilding.identifier" minOccurs="0"/>
  <xsd:element name="street.name.text" minOccurs="0"/>
  <xsd:element name="district.name.text" minOccurs="0"/>
  <xsd:element name="town.name.text" minOccurs="0"/>
  <xsd:element name="state.identifier" minOccurs="0"/>
  <xsd:element name="postCode.identifier" type="xsd:string" minOccurs="0"/>
  <xsd:element name="country.code" minOccurs="0">
    <xsd:complexType>
      <xsd:simpleContent>
        <xsd:extension base="xsd:string">
          <xsd:attribute name="isoCountryCode" type="xsd:string" use="required"/>
        </xsd:extension>
      </xsd:simpleContent>
    </xsd:complexType>
  </xsd:element>
  <xsd:element name="postOfficeBox.identifier" minOccurs="0"/>
  <xsd:element name="building.identifier" minOccurs="0"/>
  <xsd:element name="suite.identifier" minOccurs="0"/>
  <xsd:element name="mailDelivery.subLocation.identifier" minOccurs="0"/>
  <xsd:element name="floor.identifier" minOccurs="0"/>
  <xsd:element name="lot.identifier" minOccurs="0"/>
  <xsd:element name="block.identifier" minOccurs="0"/>
  <xsd:element name="districtSubDivision.identifier" minOccurs="0"/>
  <xsd:element name="region.identifier" minOccurs="0"/>
  <xsd:element name="county.identifier" minOccurs="0"/>
  <xsd:element name="postalAddress.line1.text" minOccurs="0"/>
  <xsd:element name="postalAddress.line2.text" minOccurs="0"/>
  <xsd:element name="postalAddress.line3.text" minOccurs="0"/>
  <xsd:element name="postalAddress.line4.text" minOccurs="0"/>
  <xsd:element name="postalAddress.line5.text" minOccurs="0"/>
</xsd:sequence>
</xsd:complexType>
</xsd:schema>

```

## ***communicationNumber.type***

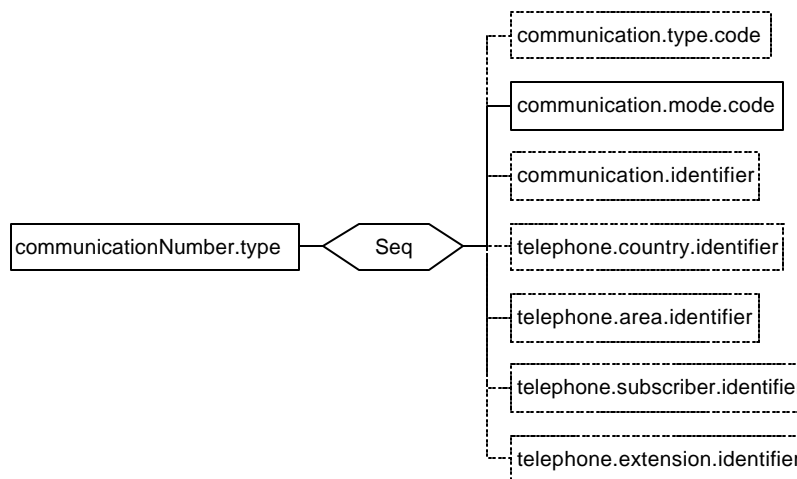

```

<?xml version="1.0" encoding="UTF-8"?>
<xsd:schema xmlns:xsd="http://www.w3.org/2001/XMLSchema" elementFormDefault="qualified">

```

```

<xsd:complexType name="communicationNumber.type">
  <xsd:annotation>
    <xsd:documentation>The type of communication details</xsd:documentation>
  </xsd:annotation>
  <xsd:sequence>
    <xsd:element name="communication.type.code" type="xsd:string" minOccurs="0"/>
    <xsd:element name="communication.mode.code" type="xsd:string"/>
    <xsd:element name="communication.identifier" type="xsd:string" minOccurs="0"/>
    <xsd:element name="telephone.country.identifier" type="xsd:string" minOccurs="0"/>
    <xsd:element name="telephone.area.identifier" type="xsd:string" minOccurs="0"/>
    <xsd:element name="telephone.subscriber.identifier" type="xsd:string" minOccurs="0"/>
    <xsd:element name="telephone.extension.identifier" type="xsd:string" minOccurs="0"/>
  </xsd:sequence>
</xsd:complexType>
</xsd:schema>

```

## *period.type*

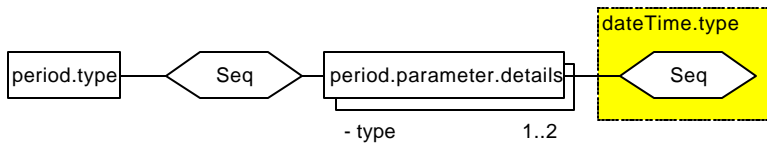

```

<?xml version="1.0" encoding="UTF-8"?>
<!-- edited with XML Spy v3.5 (http://www.xmlspy.com) by John Glaubitz (Vertex Inc.) -->
<xsd:schema xmlns:xsd="http://www.w3.org/2000/10/XMLSchema" elementFormDefault="qualified">
  <xsd:include schemaLocation="dateTimeType.xsd"/>
  <xsd:complexType name="period.type">
    <xsd:sequence>
      <xsd:element name="period.parameter.details" maxOccurs="2">
        <xsd:complexType>
          <xsd:complexContent>
            <xsd:extension base="dateTime.type">
              <xsd:attribute name="type">
                <xsd:simpleType>
                  <xsd:restriction base="xsd:string">
                    <xsd:enumeration value="period start"/>
                    <xsd:enumeration value="period end"/>
                    <xsd:enumeration value="time span"/>
                  </xsd:restriction>
                </xsd:simpleType>
              </xsd:attribute>
            </xsd:extension>
          </xsd:complexContent>
        </xsd:complexType>
      </xsd:element>
    </xsd:sequence>
  </xsd:complexType>
</xsd:schema>

```

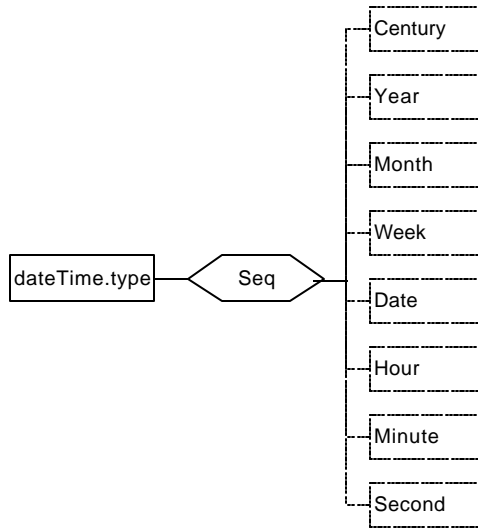
**dateTime.type**

```

<?xml version="1.0" encoding="UTF-8"?>
<xsd:schema xmlns:xsd="http://www.w3.org/2000/10/XMLSchema" elementFormDefault="qualified">
  <xsd:complexType name="dateTime.type">
    <xsd:annotation>
      <xsd:documentation>A particular point in the progression of time together with relevant supplementary
informaiton</xsd:documentation>
    </xsd:annotation>
    <xsd:sequence>
      <xsd:element name="century" type="xsd:integer" minOccurs="0"/>
      <xsd:element name="year" type="xsd:year" minOccurs="0"/>
      <xsd:element name="month" type="xsd:month" minOccurs="0"/>
      <xsd:element name="week" minOccurs="0">
        <xsd:simpleType>
          <xsd:restriction base="xsd:integer">
            <xsd:minInclusive value="1"/>
            <xsd:maxInclusive value="52"/>
          </xsd:restriction>
        </xsd:simpleType>
      </xsd:element>
      <xsd:element name="date" type="xsd:date" minOccurs="0"/>
      <xsd:element name="hour" type="xsd:timeInstant" minOccurs="0"/>
      <xsd:element name="minute" minOccurs="0">
        <xsd:simpleType>
          <xsd:restriction base="xsd:integer">
            <xsd:minInclusive value="0"/>
            <xsd:maxInclusive value="60"/>
          </xsd:restriction>
        </xsd:simpleType>
      </xsd:element>
      <xsd:element name="second" minOccurs="0">
        <xsd:simpleType>
          <xsd:restriction base="xsd:integer">
            <xsd:minInclusive value="0"/>
            <xsd:maxInclusive value="60"/>
          </xsd:restriction>
        </xsd:simpleType>
      </xsd:element>
    </xsd:sequence>
  </xsd:complexType>
</xsd:schema>
  
```

## Amount

```
<?xml version="1.0" encoding="UTF-8"?>
<xsd:schema xmlns:xsd="http://www.w3.org/2000/10/XMLSchema" elementFormDefault="qualified">
  <xsd:complexType name="amount.type">
    <xsd:annotation>
      <xsd:documentation>A monetary amount expressed in units of currency</xsd:documentation>
    </xsd:annotation>
    <xsd:simpleContent>
      <xsd:extension base="xsd:decimal">
        <xsd:attribute name="isoCurrencyName" type="xsd:string" use="optional" value="US Dollar"/>
        <xsd:attribute name="isoCurrencyCodeAlpha" type="xsd:string" use="optional" value="USD"/>
        <xsd:attribute name="isoCurrencyCodeNum" type="xsd:decimal" use="optional" value="840"/>
        <xsd:attribute name="isoCountryCode" type="xsd:string" use="optional" value="US"/>
      </xsd:extension>
    </xsd:simpleContent>
  </xsd:complexType>
</xsd:schema>
```

## Quantity

```
<?xml version="1.0" encoding="UTF-8"?>
<xsd:schema xmlns:xsd="http://www.w3.org/2000/10/XMLSchema" elementFormDefault="qualified">
  <xsd:complexType name="quantity.type">
    <xsd:annotation>
      <xsd:documentation>A number of non-monetary units together with relevant supplementary information</xsd:documentation>
    </xsd:annotation>
    <xsd:sequence>
      <xsd:element name="unitOfMeasure" minOccurs="0"/>
    </xsd:sequence>
  </xsd:complexType>
</xsd:schema>
```

## Currency

```
<?xml version="1.0" encoding="UTF-8"?>
<xsd:schema xmlns:xsd="http://www.w3.org/2001/XMLSchema" elementFormDefault="qualified">
  <xsd:complexType name="currency.type">
    <xsd:annotation>
      <xsd:documentation>Currency data type</xsd:documentation>
    </xsd:annotation>
    <xsd:attribute name="isoCurrencyName" type="xsd:string" use="required" default="US Dollar"/>
    <xsd:attribute name="isoCurrencyCodeAlpha" type="xsd:string" use="required" default="USD"/>
    <xsd:attribute name="isoCurrencyCodeNum" use="required" default="840">
      <xsd:simpleType>
        <xsd:restriction base="xsd:decimal">
          <xsd:minInclusive value="1"/>
          <xsd:maxInclusive value="1000"/>
        </xsd:restriction>
      </xsd:simpleType>
    </xsd:attribute>
    <xsd:attribute name="isoCountryCode" use="required" default="US">
      <xsd:simpleType>
        <xsd:restriction base="xsd:string">
          <xsd:length value="2"/>
        </xsd:restriction>
      </xsd:simpleType>
    </xsd:attribute>
  </xsd:complexType>
</xsd:schema>
```



11/16/01

```
</xsd:attribute>  
</xsd:complexType>  
</xsd:schema >
```